



modulex

INTERIOR
PRODUCTS.

GLOBAL VISION • LOCAL REACH • ONE COMPANY

INTERIOR SIGNS.

General characteristics:

- > Modularity
- > Customizable
- > Different texting technologies

Technical lifetime
of 10 years:

- > Modulex products are covered by a general 2 - year product guarantee

Modulex Interior
Signs Products:

**Detta är våra underkategorier för
Inomhussystem/Invändig skyltning**

- > Pacific Interior
- > Messenger Interior
- > **Infinity**
- > Macer Interior
- > **Via Interior**
- > Sirius
- > **Basic Interior**
- > **Etronit**
- > **GreenBond™**
- > Breeze
- > **Signs for the visually impaired** **Taktil text**
- > **Safety signs**



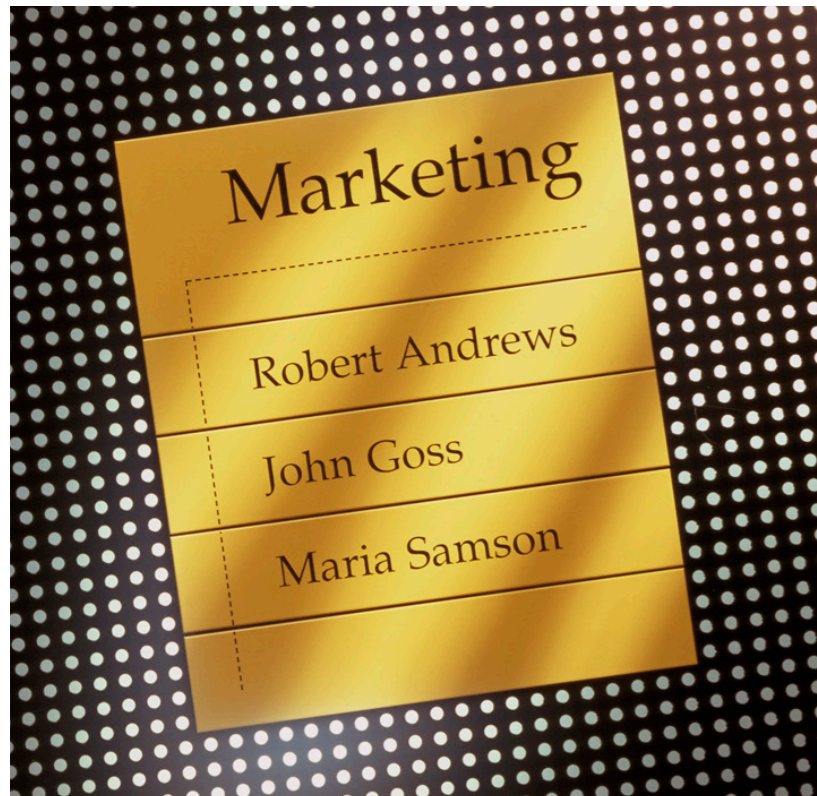
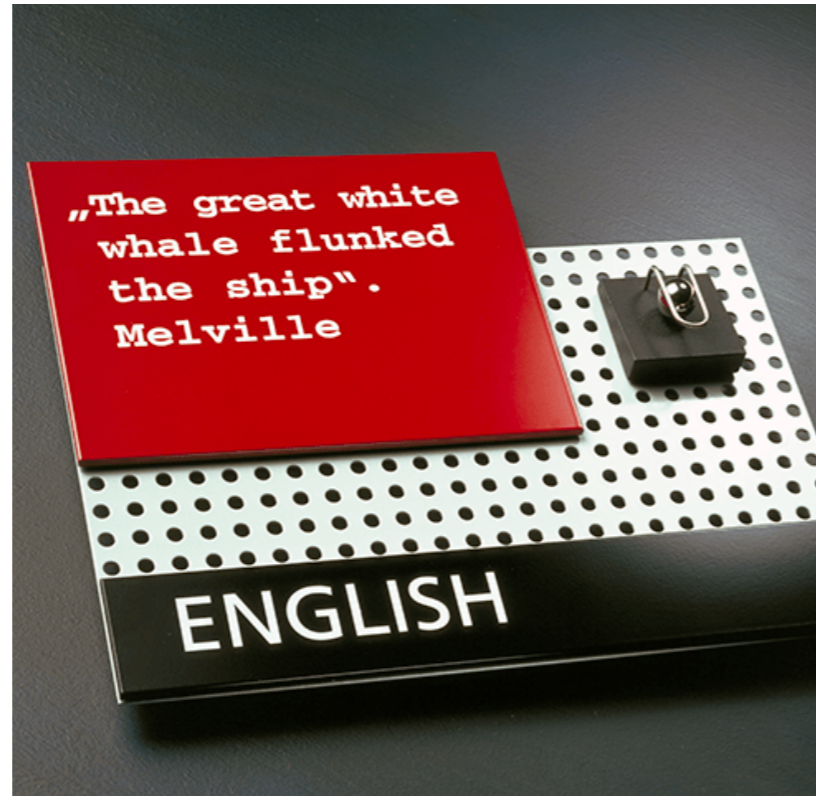
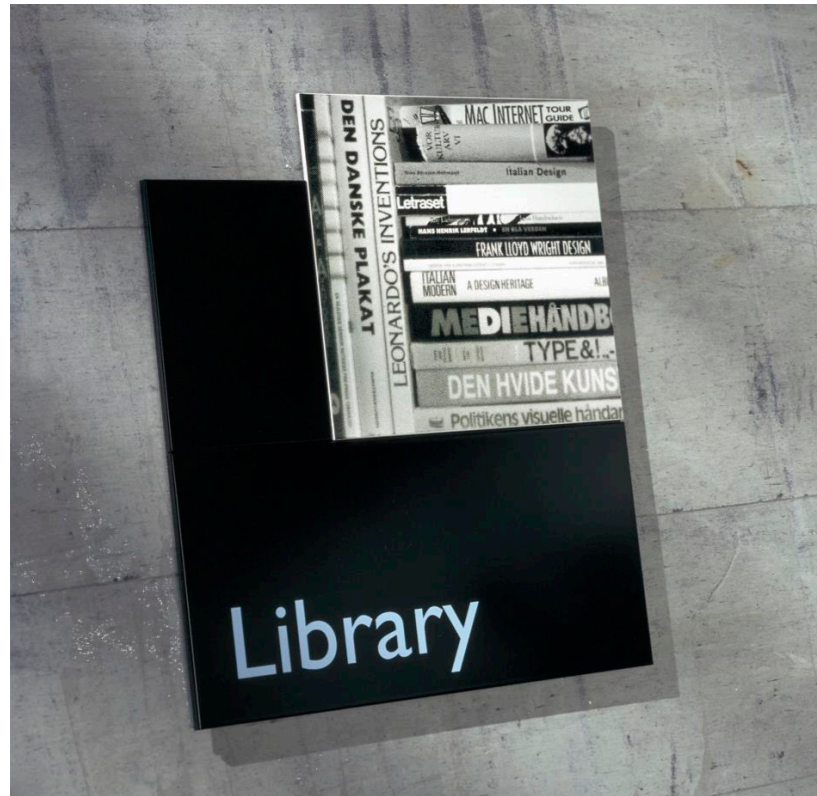

INFINITY CLASSIC AND RAIL.

With unlimited colours and materials, including wood, metal and composites, the Infinity Classic is a flexible option. Its fixed back plate and exchangeable fronts allow for direct translation of your design needs. For a lighter solution the grid can be changed for a rail.

Infinity Classic product line consist of:











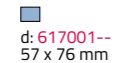
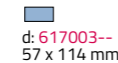
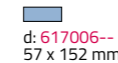
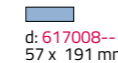
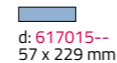
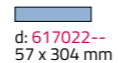
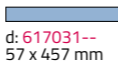
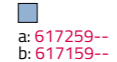

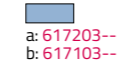

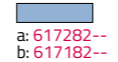
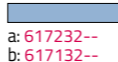
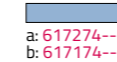

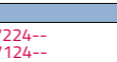

- Wall signs

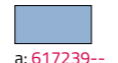
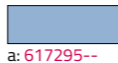

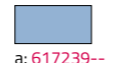
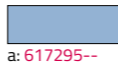

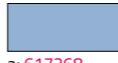
Wall

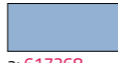





















a: Grid
b: Rail

 d: 617001-- 57 x 76 mm 2.25" x 3"	 d: 617003-- 57 x 114 mm 2.25" x 4.5"	 d: 617005-- 57 x 152 mm 2.25" x 6"	 d: 617008-- 57 x 191 mm 2.25" x 7.5"	 d: 617015-- 57 x 229 mm 2.25" x 9"	 d: 617022-- 57 x 304 mm 2.25" x 12"	 d: 617031-- 57 x 457 mm 2.25" x 18"			
 a: 617259-- b: 617159-- c: 616059-- d: 617002-- 76 x 76 mm 3" x 3"	 d: 617004-- 76 x 114 mm 3" x 4.5"	 a: 617217-- b: 617117-- c: 616117-- d: 617007-- 76 x 152 mm 3" x 6"	 a: 617203-- b: 617103-- c: 530103-- d: 530203-- 76 x 191 mm 3" x 7.5"	 a: 617216-- b: 617116-- c: 616116-- d: 617016-- 76 x 229 mm 3" x 9"	 a: 617282-- b: 617182-- c: 616082-- d: 617023-- 76 x 304 mm 3" x 12"	 a: 617232-- b: 617132-- c: 616132-- d: 617032-- 76 x 457 mm 3" x 18"	 a: 617274-- b: 617174-- c: 616074-- d: 617041-- 76 x 610 mm 3" x 24"	 a: 617224-- b: 617124-- c: 616024-- 76 x 895 mm 3" x 35.25"	
	 d: 617005-- 114 x 114 mm 4.5" x 4.5"	 a: 617289-- b: 617189-- c: 616089-- d: 617089-- 114 x 152 mm 4.5" x 6"	 a: 617261-- b: 617161-- c: 616061-- d: 617061-- 114 x 191 mm 4.5" x 7.5"	 a: 617233-- b: 617133-- c: 616133-- d: 617033-- 114 x 457 mm 4.5" x 18"	 a: 617275-- b: 617175-- c: 616075-- d: 617042-- 114 x 610 mm 4.5" x 24"	 a: 617225-- b: 617125-- c: 616025-- d: 617052-- 114 x 895 mm 4.5" x 35.25"			
		 a: 617204-- b: 617104-- c: 530104-- d: 530204-- 152 x 152 mm 6" x 6"	 d: 617209-- 152 x 191 mm 6" x 7.5"	 a: 617239-- b: 617139-- c: 616039-- d: 617039-- 152 x 304 mm 6" x 12"	 a: 617295-- b: 617195-- c: 616095-- d: 617034-- 152 x 457 mm 6" x 18"	 a: 617296-- b: 617196-- c: 616096-- d: 617043-- 152 x 610 mm 6" x 24"	 a: 617276-- b: 617176-- c: 616076-- d: 617044-- 152 x 895 mm 6" x 35.25"		
			 a: 617263-- b: 617163-- c: 616063-- d: 617063-- 191 x 191 mm 7.5" x 7.5"	 a: 617268-- b: 617168-- c: 616068-- d: 617068-- 191 x 457 mm 7.5" x 18"	 a: 617277-- b: 617177-- c: 616077-- d: 617045-- 191 x 610 mm 7.5" x 24"	 a: 617279-- b: 617179-- c: 616079-- d: 617046-- 191 x 895 mm 7.5" x 35.25"			
			 a: 617268-- c: 616068-- 457 x 191 mm 18" x 7.5"						



Wall

a: Grid
b: Rail

 a: 617205-- b: 617105-- c: 530105-- d: 530205-- 229 x 229 mm 9" x 9"	 a: 617286-- b: 617186-- c: 616086-- d: 617024-- 229 x 304 mm 9" x 12"	 a: 617287-- b: 617187-- c: 616087-- d: 617035-- 229 x 457 mm 9" x 18"	 a: 617207-- b: 617107-- c: 530107-- d: 530207-- 229 x 610 mm 9" x 24"	 d: 617055-- 229 x 895 mm 9" x 35.25"
 a: 617286-- c: 616086-- d: 617024-- 304 x 229 mm 12" x 9"	 a: 617283-- b: 617183-- c: 616083-- d: 617025-- 304 x 304 mm 12" x 12"	 a: 617269-- b: 617169-- c: 616069-- d: 617036-- 304 x 457 mm 12" x 18"	 a: 617284-- b: 617184-- c: 616084-- d: 617045-- 304 x 610 mm 12" x 24"	
 a: 617287-- c: 616087-- d: 617035-- 457 x 229 mm 18" x 9"	 a: 617269-- c: 616069-- d: 617036-- 457 x 304 mm 18" x 12"	 a: 617271-- b: 617171-- c: 616071-- d: 617037-- 457 x 457 mm 18" x 18"	 a: 617277-- b: 617177-- c: 616077-- d: 617046-- 457 x 610 mm 18" x 24"	 a: 617280-- b: 617180-- c: 616080-- d: 617057-- 457 x 895 mm 18" x 35.25"
 a: 617207-- c: 530107-- d: 530207-- 610 x 229 mm 24" x 9"	 a: 617284-- c: 616084-- d: 617045-- 610 x 304 mm 24" x 12"	 a: 617277-- c: 616077-- d: 617037-- 610 x 457 mm 24" x 18"	 a: 617278-- b: 617178-- c: 616078-- d: 617046-- 610 x 610 mm 24" x 24"	 a: 617281-- b: 617181-- c: 616081-- d: 617057-- 610 x 895 mm 24" x 35.25"
		 a: 617280-- c: 616080-- d: 617057-- 895 x 457 mm 35.25" x 18"	 a: 617281-- c: 616081-- d: 617057-- 895 x 610 mm 35.25" x 24"	 a: 617227-- b: 617127-- c: 616027-- 895 x 895 mm 35.25" x 35.25"



GRID WALL SIGN

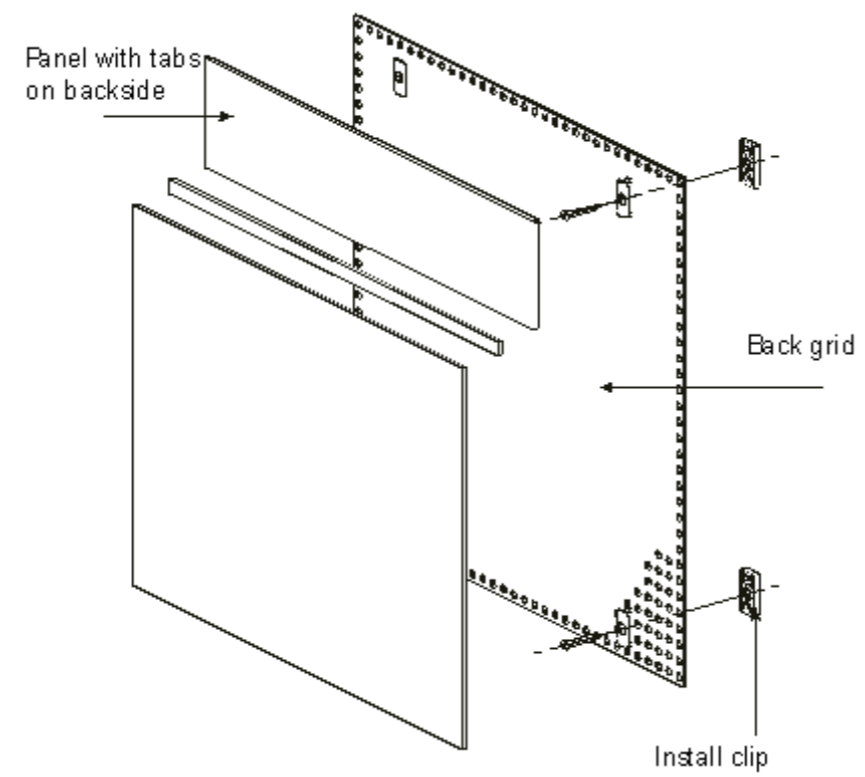

RAIL WALL SIGN

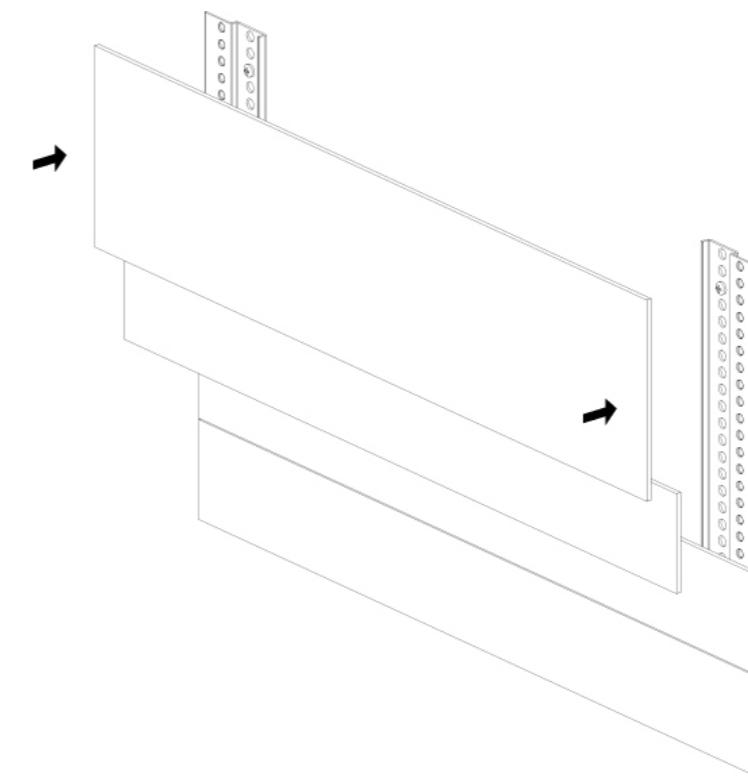

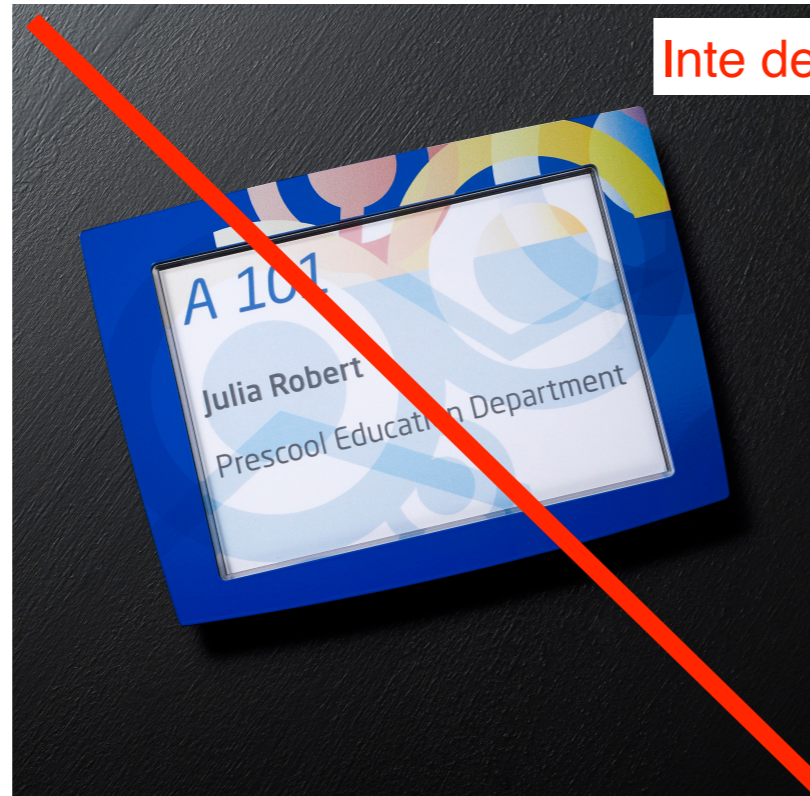

Inte dessa bilder



INFINITY BASIC, BLAZON AND ELLIPSIS.

Infinity Basic is a system in square format making it possible to match static and paperflex signs both horizontally and vertically. But who says that signs always have to be rectangular? With Infinity Blazon and Ellipsis, different shapes are available. You also have the opportunity to create your own customized dimensions and shapes. There are unlimited possibilities and with the use of graphic features you can create a 100 % personal sign supporting the design

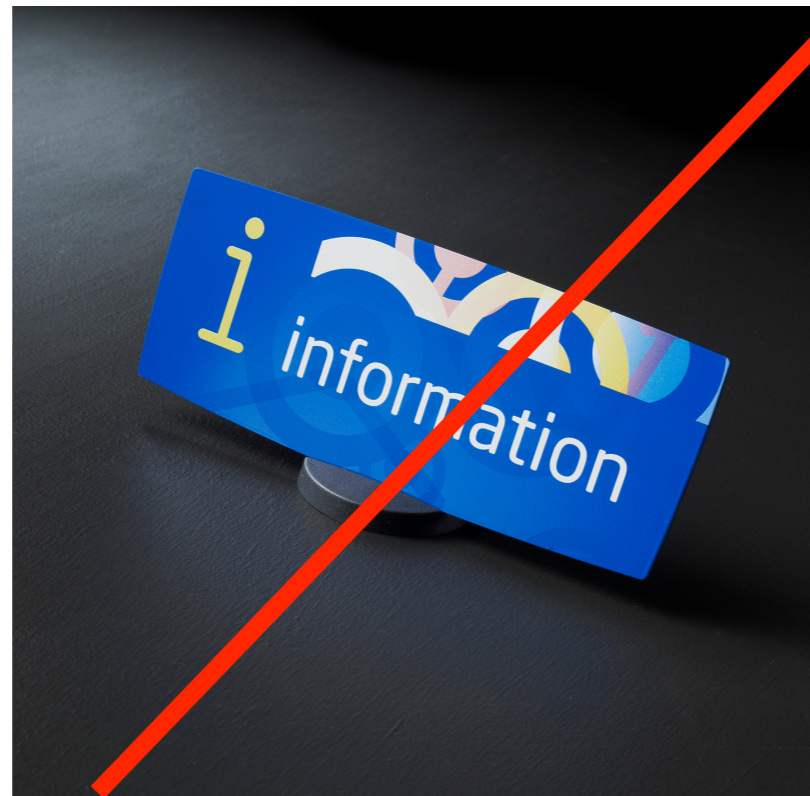

Infinity Classic product line consist of:

- > Wallsigns
- > Suspended signs
- > Projecting signs
- > Paperflex signs
- > Desk signs
- > Floor signs
- > Monoliths





BASIC INTERIOR.

Basic Interior Bond includes a broad assortment of ACM panels. The white surface combined with our print technologies makes it possible to create interesting graphic solutions for wall-mounted, projecting and suspended signs. The Basic Interior Steel and Safety Signs lines are also on offer.

Basic Interior product line consist of:

- › Wall signs
- › Paperflex signs



BASIC INTERIOR.

 Paperflex

 Paperflex with header

 Wall

a: = Front lock without tape
 b: = Front lock with tape
 c: = No lock without tape
 d: = No lock with tape



 a: 185004--
 b: 185104--
 c: 185054--
 d: 185154--
 210 x 148,5 mm (A5P)
 8.3" x 5.8"

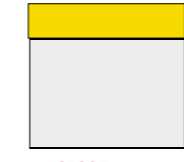

 a: 185002--
 b: 185102--
 c: 185052--
 d: 185152--
 148,5 x 105 mm (A6P)
 5.8" x 4.1"

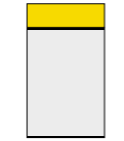

 a: 185642
 b: 185742
 c: 185652
 d: 185752
 (Tabloid)
 430 x 280
 16.5" x 11"

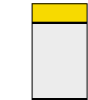

 a: 185207--
 b: 185307--
 Header: 93 mm / 3.7"
 390 x 420 (A3L)
 15.4" x 16.5"



 a: 185208--
 b: 185308--
 Header: 78 mm / 3"
 498 x 297(A3P)
 19.6" x 11.7"

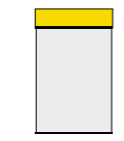

 a: 185206--
 b: 185306--
 Header: 64 mm / 2.5"
 361 x 210 (A4P)
 14.2" x 8.3"



 a: 185204--
 b: 185304--
 Header: 50 mm / 2"
 260 x 148,5 mm (A5P)
 10.2" x 5.8"

 a: 185202--
 b: 185302--
 Header: 50 mm / 2"
 198,5 x 105 mm (A6P)
 7.8" x 4.1"

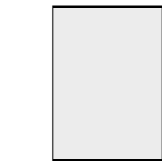

 a: 185639
 b: 185739
 Header: 50 mm / 2"
 329 x 216 mm
 13" x 8.5" (Letter)

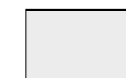

 a: 185001--
 b: 185101--
 c: 185051--
 d: 185151--
 105 x 148,5 (A6L)--
 4.1" x 5.8"



 a: 185008--
 b: 185108--
 c: 185058--*
 d: 185158--*
 420 x 297(A3P)
 16.5" x 11.7"



 a: 185641
 b: 185741
 c: 185651
 d: 185751
 (Letter)
 279 x 216
 11" x 8.5"

Wall sign incl. permanent panel. Paperflex panel, matt paperflex front, for fixation with double sided tape.

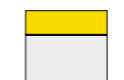

 a: 185205--
 b: 185305--
 Header: 78 mm / 3"
 288 x 297 (A4L)
 11.3" x 11.7"



 a: 185213--
 b: 185313--
 Header: 50 mm / 2"
 198,5 x 210 mm (A5L)
 7.5" x 8.3"

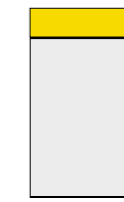

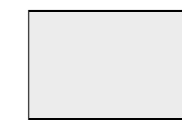
 a: 185203--
 b: 185303--
 Header: 64 mm / 2.5"
 212,5 x 210 mm (A5L)
 8.4" x 8.3"

 a: 185201--
 b: 185301--
 Header: 50 mm / 2"
 155 x 148,5 (A6L)
 6.1" x 5.8"



 a: 185640
 b: 185740
 Header: 78 mm / 3"
 508 x 280 mm
 19.9" x 11" (Tabloid)



 a: 185007--
 b: 185107--
 c: 185057--
 d: 185157--
 297 x 420 (A3L)
 11.7" x 16.5"



 a: 185005--
 b: 185105--
 c: 185055--
 d: 185155--
 210 x 297 (A4L)
 8.3" x 11.7"



 a: 185006--
 b: 185106--
 c: 185056--
 d: 185156--
 297 x 210 (A4P)
 11.7" x 8.3"

Paperflex sign, clear/matt paperflex front, for fixation with double sided tape.

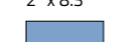

 a: 185003--
 b: 185103--
 c: 185053--
 d: 185153--
 148,5 x 210 mm (A5L)
 5.8" x 8.3"

 a: 185805--
 93 x 420 mm
 3.7" x 16.5"

 a: 185804--
 78 X 297 mm
 3.1" x 11.7"



 a: 185803--
 64 x 210 mm
 2.5" x 8.3"

 a: 185802--
 50 x 148,5 mm
 2" x 5.8"



 a: 185801--
 50 x 105 mm
 2" x 4.1"

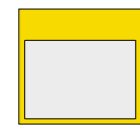
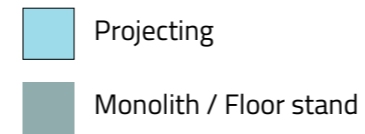
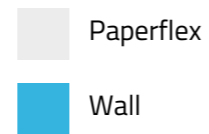
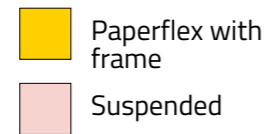

INFINITY BASIC.

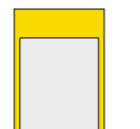

531518--
419 x 457 mm
16.5" x 18"
(A3 L)



531517--
533 x 343 mm
21" x 13.5"
(A3 P)



531516--
304 x 343 mm
12" x 13.5"
(A4 L)



531515--
381 x 247 mm
15" x 9.75"
(A4 P)

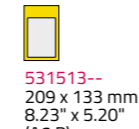

531513--
209 x 133 mm
8.23" x 5.20"
(A6 P)

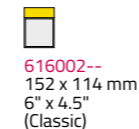

616002--
152 x 114 mm
6" x 4.5"
(Classic)

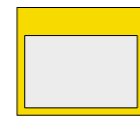

544318--
419 x 476 mm
16.5" x 18.75"
(Tabloid L)

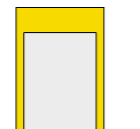

544317--
533 x 343 mm
21" x 13.5"
(Tabloid P)



544316--
304 x 343 mm
12" x 13.5"
(Letter L)



544315--
381 x 247 mm
15" x 9.75"
(Letter P)

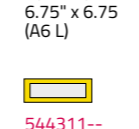

544311--
89 x 257 mm
3.5" x 10.1"

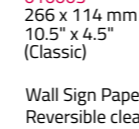

616003--
266 x 114 mm
10.5" x 4.5"
(Classic)

Wall Sign Paperflex
Alu. frame
Matt front

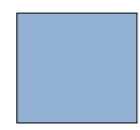

616070--
419 x 457 mm
16.5" x 18"

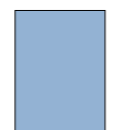

616073--
533 x 343 mm
21" x 13.5"



616065--
304 x 343 mm
12" x 13.5"

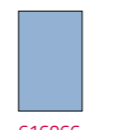

616066--
381 x 247 mm
15" x 9.75"

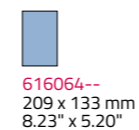

616064--
209 x 133 mm
8.23" x 5.20"

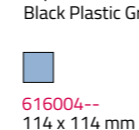

616004--
114 x 114 mm
4.5" x 4.5"
(Classic)

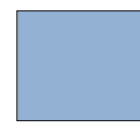

616072--
419 x 476 mm
16.5" x 18.75"

Wall Sign
Alu panel
Foam & clips
Wall clips for screw

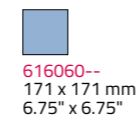

616060--
171 x 171 mm
6.75" x 6.75"

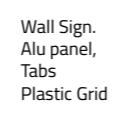

61600100
114 x 114 mm
4.5" x 4.5"
(Classic)

Wall Sign Paperflex
Reversible matt/clear front
Paper holder
Black Plastic Grid

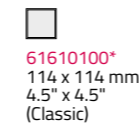

61610100*
114 x 114 mm
4.5" x 4.5"
(Classic)

Wall Sign Paperflex
Reversible matt/clear front
Paper holder
Grey Plastic Grid

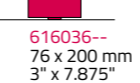

616036--
76 x 200 mm
3" x 7.875"

Desk Sign
Perm panel
Desk Foot

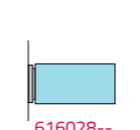

616028--
152 x 304 mm
6" x 12"

Projecting Sign
Double sided
Wall fitting included
Alu. panel painted

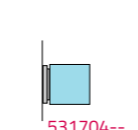

531704--
152 x 152 mm
6" x 6"

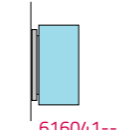

616041--
304 x 152 mm
12. x 6"



531926--
2008 x 500 mm
79.06" x 19.69"

Monolith
Tape installed
perm. alu. panels

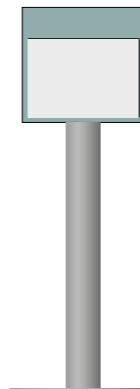

b: 616038--
419 x 457 mm (A3 L)
16.5" x 18"

Floor Support,
Paperflex Panel
Matt front
Alu. frame
Installation Plate.

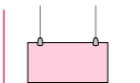

616040--
152 x 304 mm
6" x 12"

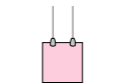

616037--
152 x 152 mm
6" x 6"

Suspended Signs.
Plain alu. panel painted double
Wire included

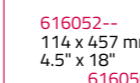

616052--
114 x 457 mm
4.5" x 18"

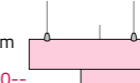

616050--
152 x 457 mm
6" x 18"

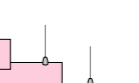

616051--
229 x 457 mm
9" x 18"

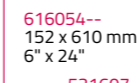

616054--
152 x 610 mm
6" x 24"

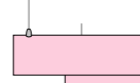

531607--
229 x 610 mm
9" x 24"

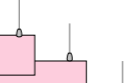

616057--
343 x 610 mm
13.5" x 24"

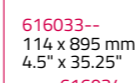

616033--
114 x 895 mm
4.5" x 35.25"

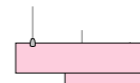

616034--
200 x 895 mm
7.875" x 35.25"

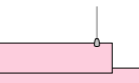

616035--
390 x 895 mm
15.375" x 35.25"

Suspended Signs
Plain alu. panel painted double
Wire included



INFINITY BASIC.

WALL SIGN WITH TAPE

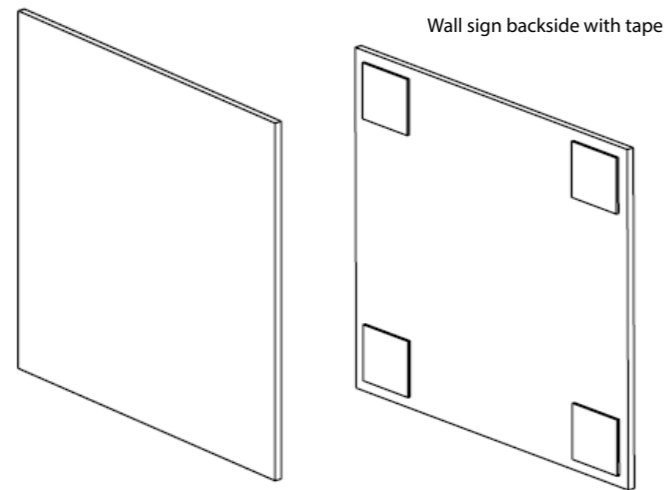

WALL SIGN WITH SCREWS

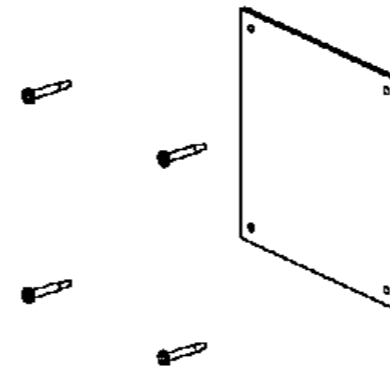

WALL SIGN PAPERFLEX

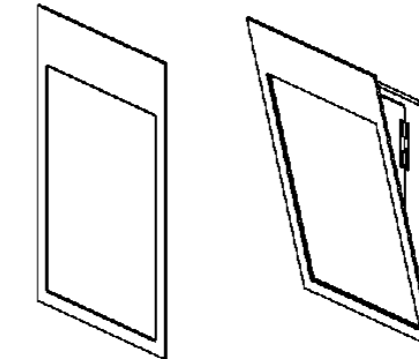

MONOLITH

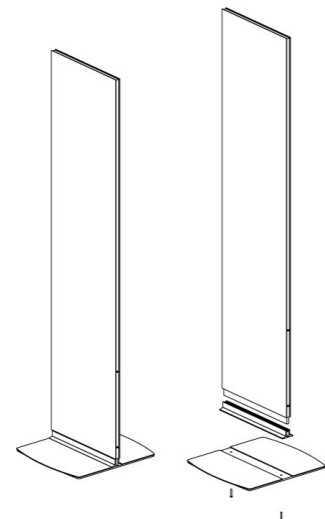

PROJECTING SIGN

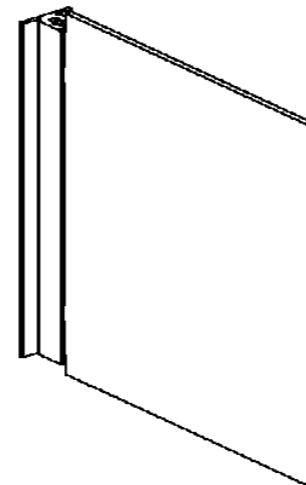
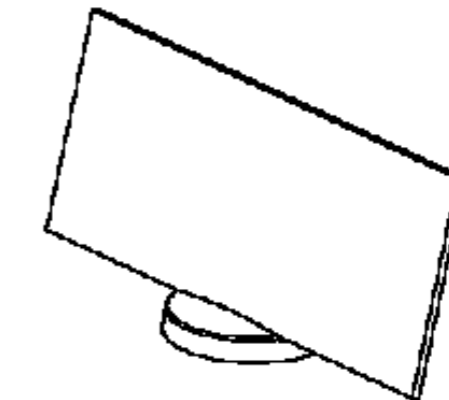
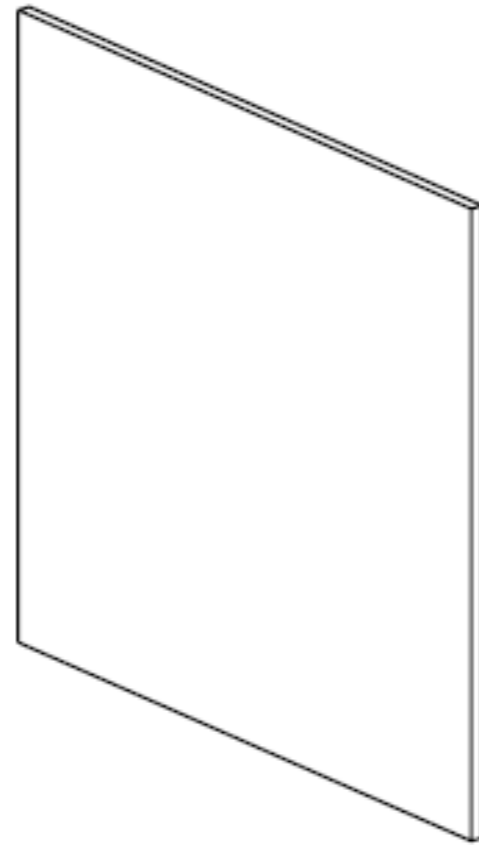

TABLE SIGN



WALL SIGN



Wall sign backside with tape

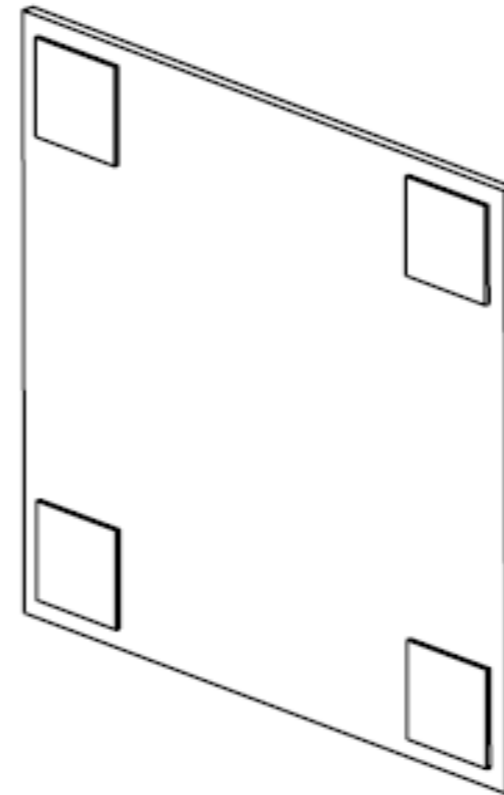



VIA INTERIOR.

The Via architectural signage system, designed in collaboration with international architecture firm C.F. Møller, is a simple interior and exterior system. Providing a flexible modular system it can easily be adapted to complex wayfinding schemes in healthcare, education, leisure and transport hubs.

The Via architectural signage system includes illuminated/non illuminated signage for both interior and exterior with flexible fixing systems adapting to building requirements including suspended (single or double sided), projecting, monoliths, wall and door signs.



Via Interior is an obvious choice for modular suspended or wall-mounted signs. The signs can easily be joined vertically or horizontally and are easy to install, update and clean. A complete series, VIA offers orientation, directional and identification signs. The look remains the same with or without LED lights.

Via Interior product line consist of:

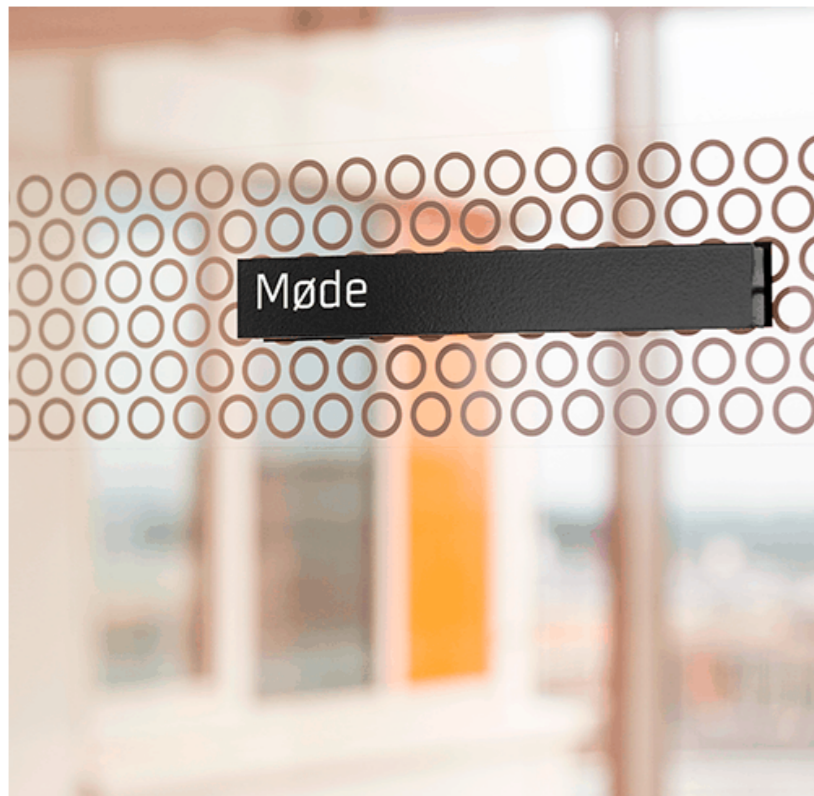
- > Wall signs
- > Suspended signs
- > Projecting signs





VIA INTERIOR.

 Suspended Header  Suspended

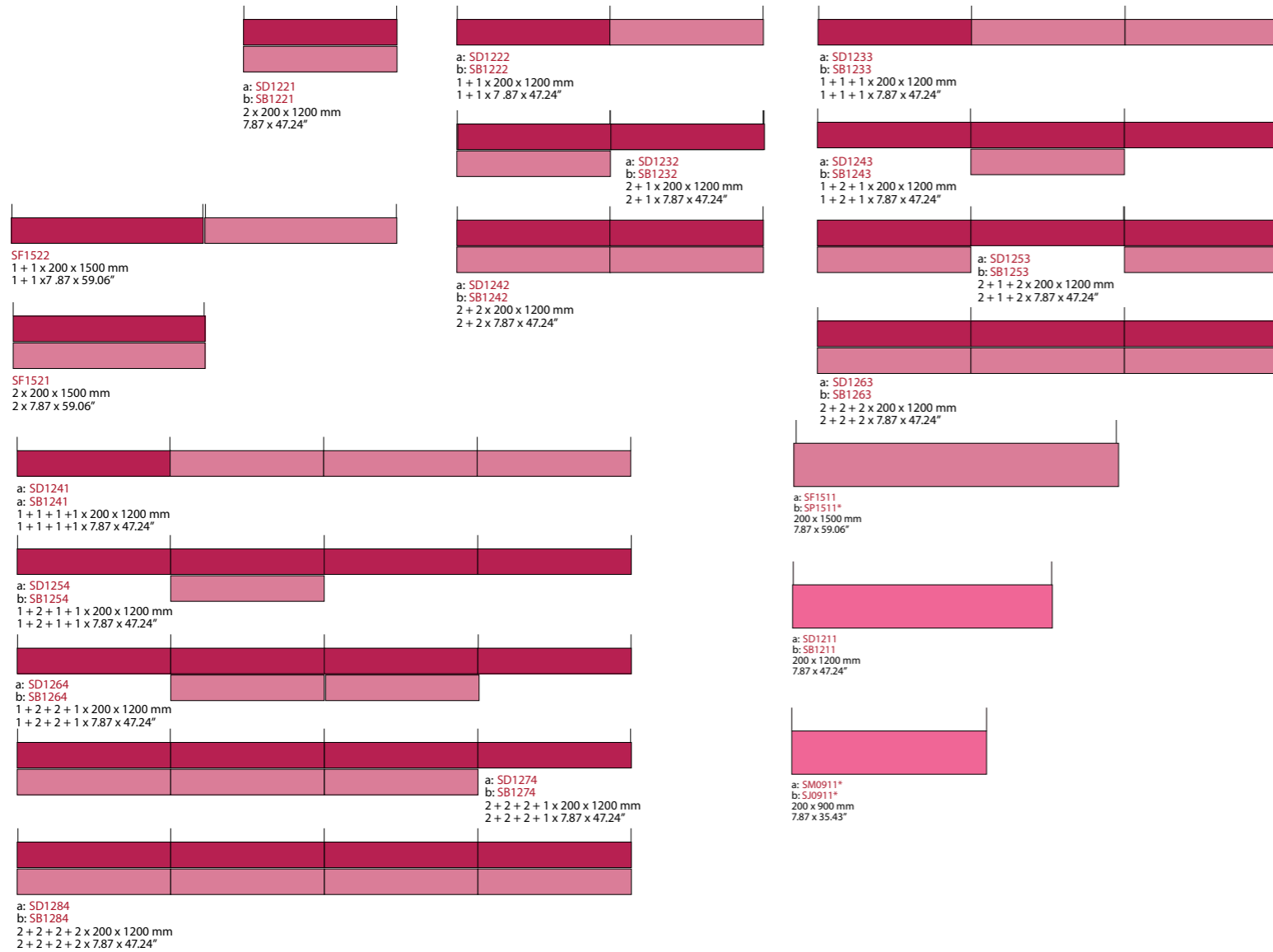
a: Non illuminated
b: Illuminated



 Wall Header  Projecting

 Wall **a: Non illuminated**
b: Illuminated

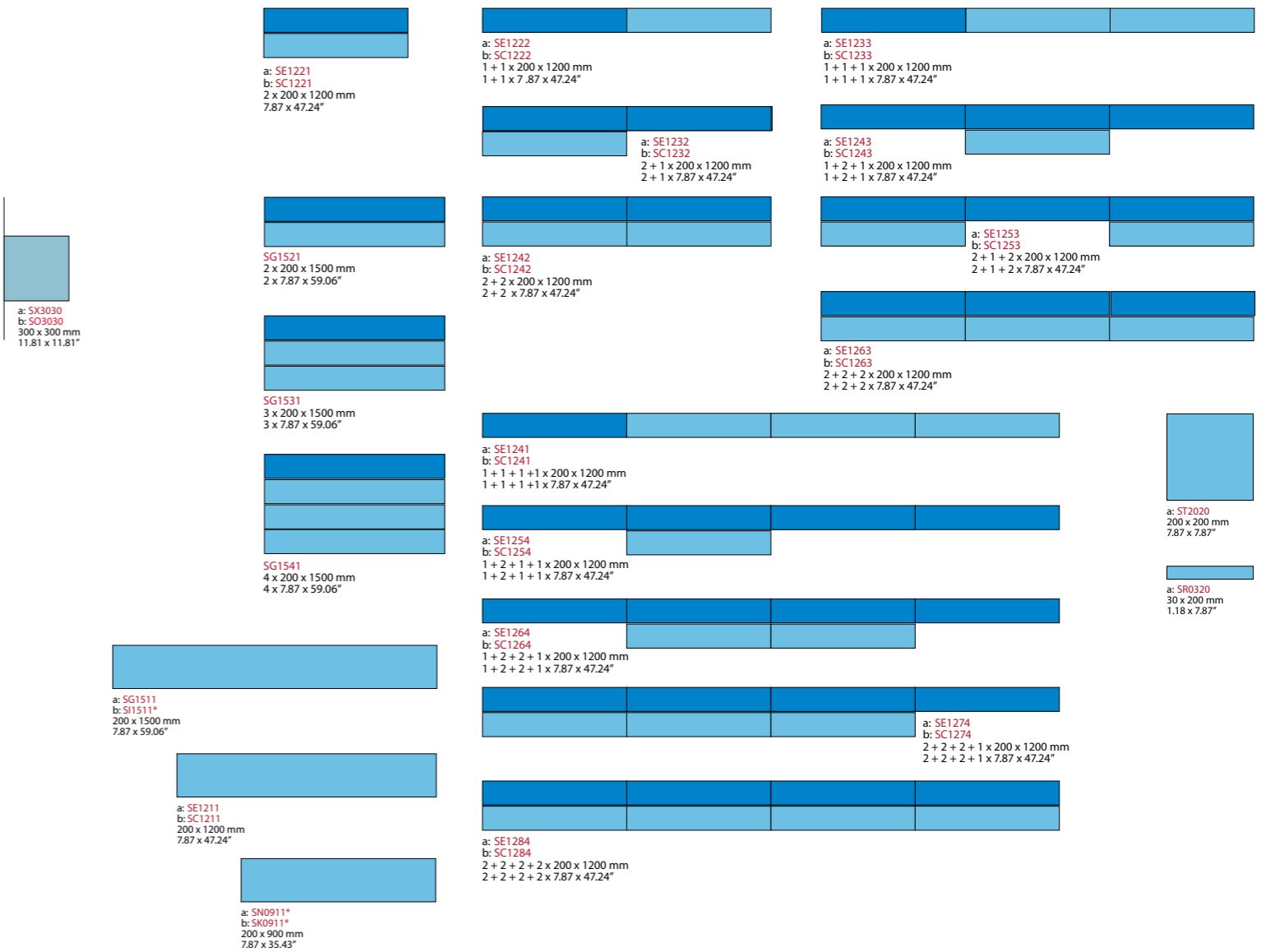

SUSPENDED SIGN

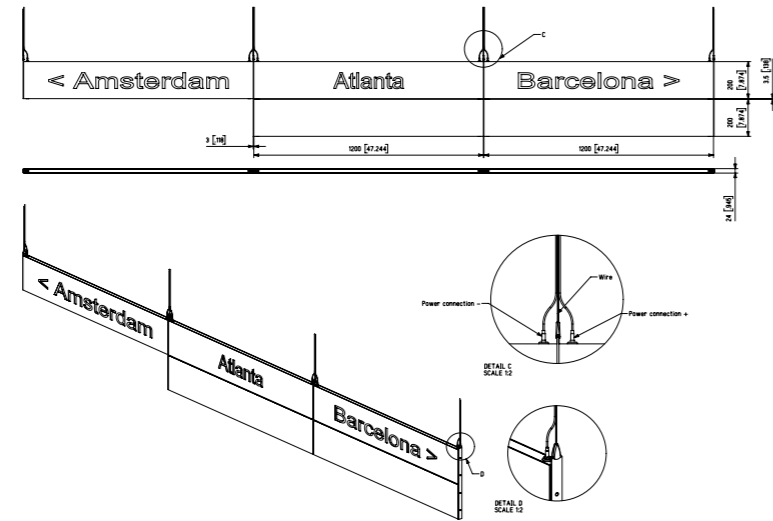

WALL SIGN

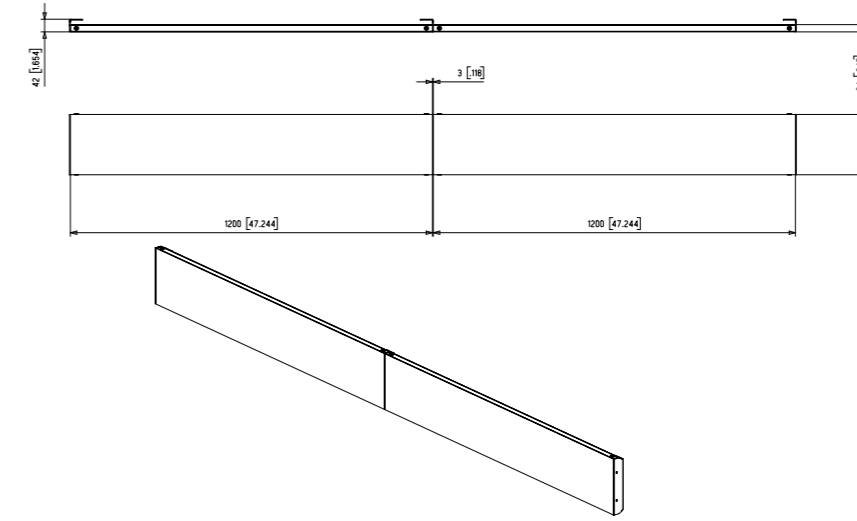

DOOR AND WALL SIGN

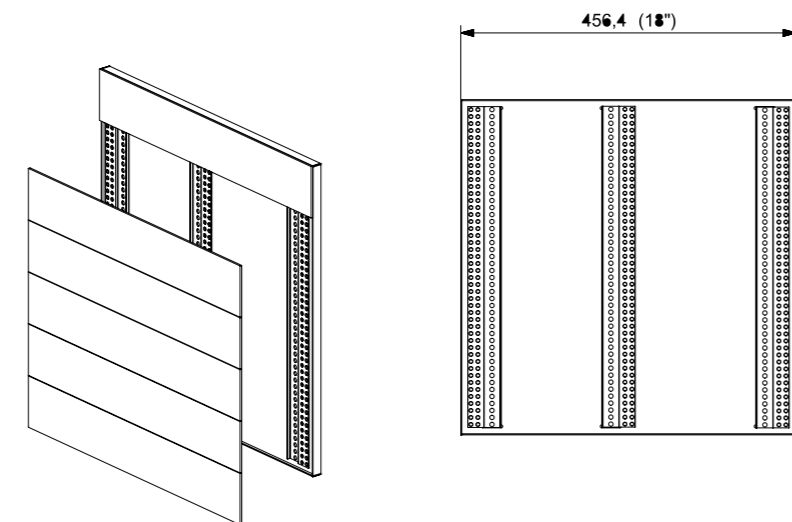

PROJECTING SIGN

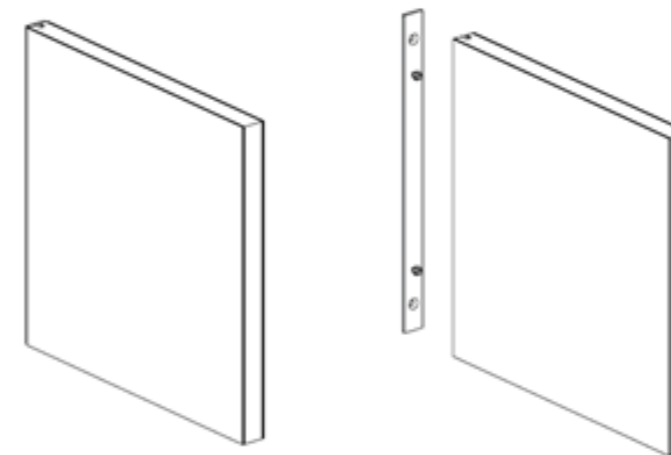

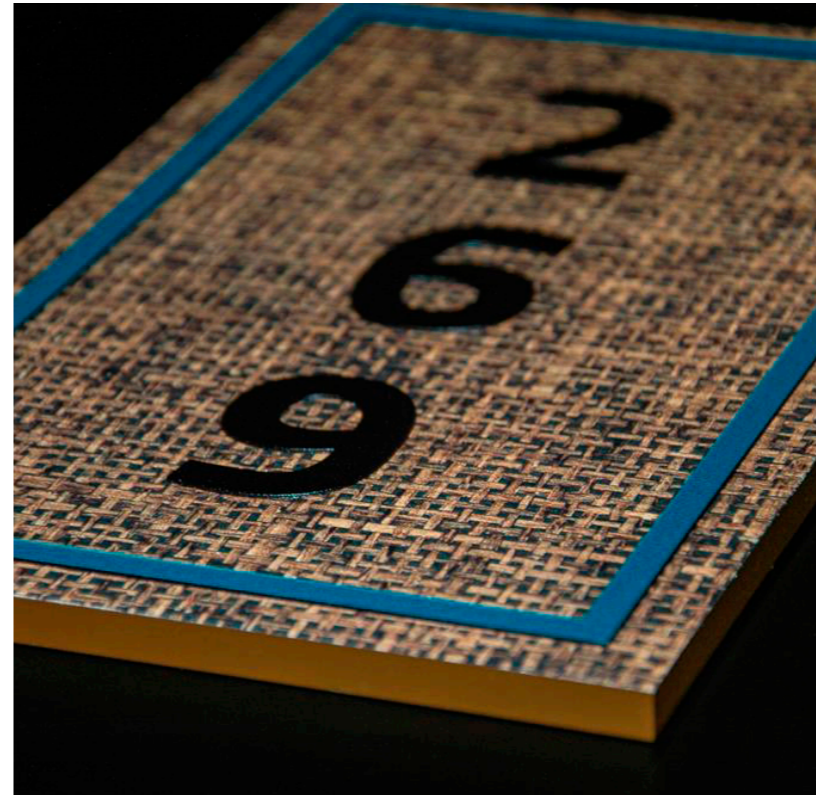
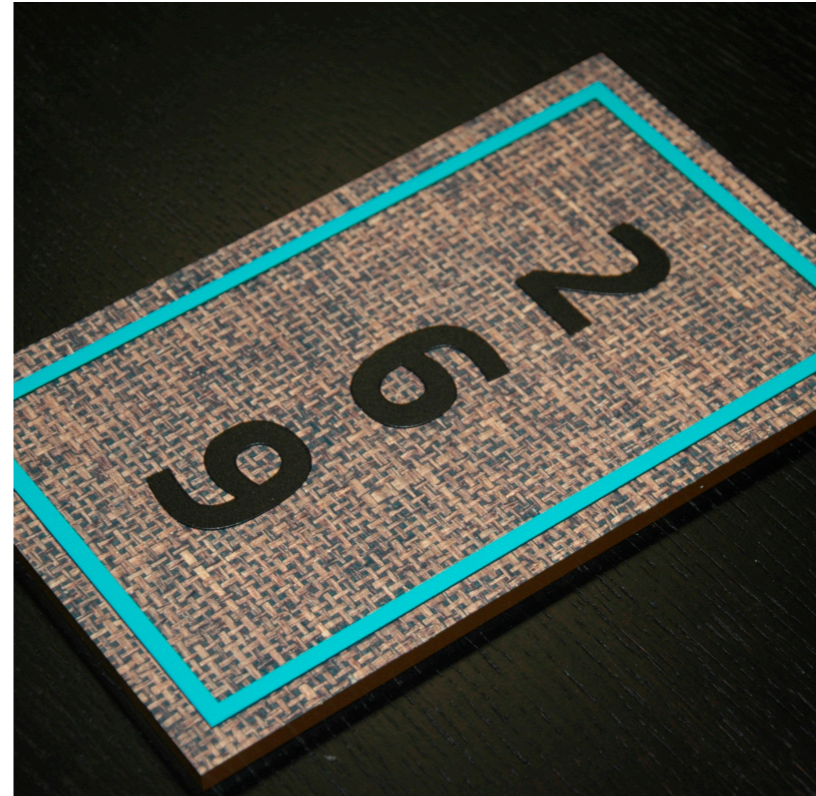

ETRONIT.



Etronit is a material made of FSC® and PEFC® paper from Nordic forests infused in synthetic resin and put together under extreme pressure and heat, that combines environmental consciousness with high-end aesthetics.

This eco-friendly signage material has a carbon footprint 53 % lower than acrylic and 41 % lower than aluminium composites (ACM).

With its focus on sustainability and innovation, Etronit is a green signage material with unmatched ecological standards: Sustainable source and cleaner production combined with an outstanding and timeless design.

Etronit is a very versatile product allowing signs anywhere from 30mm x 30mm to 1200mm x 2400mm

Etronit sign product line consist of:

- > Wall signs
- > Logo Letters
- > Custom signs



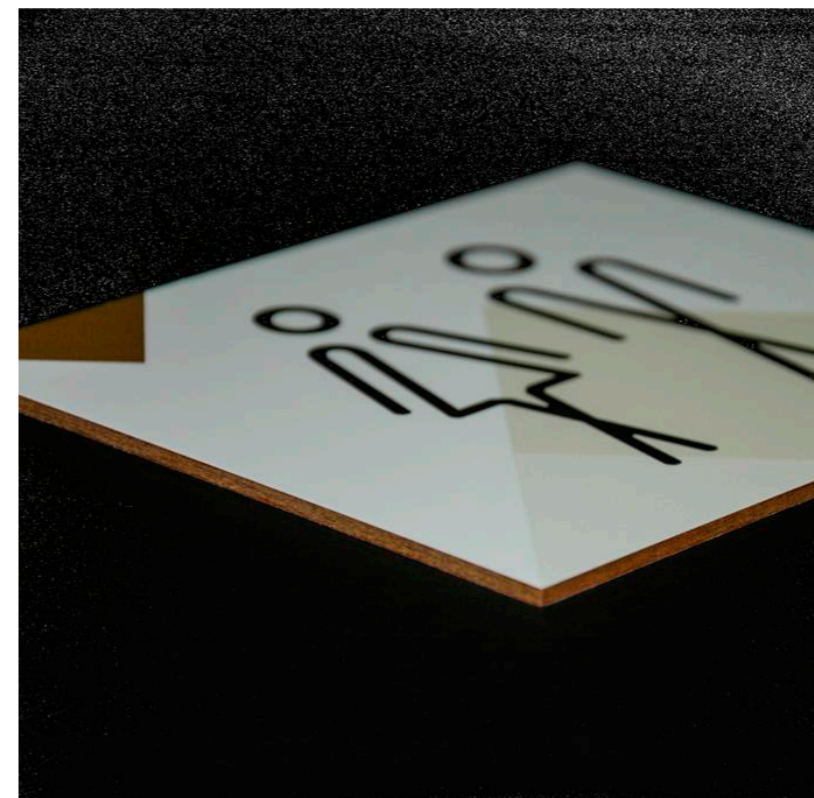

GREENBOND™.

Made of FSC® paper and polyester film, this material is a standard UV-printable material. As its name indicates, GreenBond™ has been developed as an alternative to aluminium composite (ACM) signs.

It has identical applications and resemblance to ACM but has a carbon footprint 41 % lower. Therefore, it covers a huge gap in the signage market as an eco-friendly and versatile product with possibilities equal to those of ACM.

GreenBond™ Interior product line consist of:

- › Wall signs



Wall

a: Clips and foam
b: Tape

a: 61775900
b: 61785900
76 x 76 mm
3" x 3"

a: 61778900
b: 61788900
114 x 152 mm
4.5" x 6"

a: 61770400
b: 61780400
152 x 152 mm
6" x 6"

a: 61770300
b: 61780300
76 x 191 mm
3" x 7.5"

a: 61776100
b: 61786100
114 x 191 mm
4.5" x 7.5"

a: 61772900
b: 61782900
152 x 191 mm
6" x 7.5"

a: 61776300
b: 61786300
191 x 191 mm
7.5" x 7.5"

a: 61778200
b: 61788200
76 x 304 mm
3" x 12"

a: 61773900
b: 61783900
152 x 304 mm
6" x 12"

a: 61777400
b: 61787400
76 x 610 mm
3" x 24"

a: 61777500
b: 61787500
114 x 610 mm
4.5" x 24"

a: 61779600
b: 61789600
152 x 610 mm
6" x 24"

a: 61777600
b: 61787600
191 x 610 mm
7.5" x 24"

a: 61772400
b: 61782400
76 x 895 mm
3" x 35.25"

a: 61772500
b: 61782500
114 x 895 mm
4.5" x 35.25"

a: 61777900
b: 61787900
191 x 895 mm
7.5" x 35.25"

a: 61770500
b: 61780500
229 x 229 mm
9" x 9"

a: 61778600
b: 61788600
229 x 304 mm
9" x 12"

a: 61778700
b: 61788700
229 x 457 mm
9" x 18"

a: 61770700
b: 61780700
229 x 610 mm
9" x 24"

a: 61778600
b: 61788600
304 x 229 mm
12" x 9"

a: 61778300
b: 61788300
304 x 304 mm
12" x 12"

a: 61776900
b: 61786900
304 x 457 mm
12" x 18"

a: 61778400
b: 61788400
304 x 610 mm
12" x 24"

a: 61776800
b: 61786800
457 x 191 mm
18" x 7.5"

a: 61778700
b: 61788700
457 x 229 mm
18" x 9"

a: 61776900
b: 61786900
457 x 304 mm
18" x 12"

a: 61777100
b: 61787100
457 x 457 mm
18" x 18"

a: 61777700
b: 61787700
457 x 610 mm
18" x 24"

a: 61778000
b: 61788000
457 x 895 mm
18" x 35.25"

a: 61770700
b: 61780700
610 x 229 mm
24" x 9"

a: 61778400
b: 61788400
610 x 304 mm
24" x 12"

a: 61777700
b: 61787700
610 x 457 mm
24" x 18"

a: 61777800
b: 61787800
610 x 610 mm
24" x 24"

a: 61778100
b: 61788100
610 x 895 mm
24" x 35.25"

a: 61778000
b: 61788000
895 x 457 mm
35.25" x 18"

a: 61778100
b: 61788100
895 x 610 mm
35.25" x 24"

a: 61772700
b: 61782700
895 x 895 mm
35.25" x 35.25"



WALL SIGN

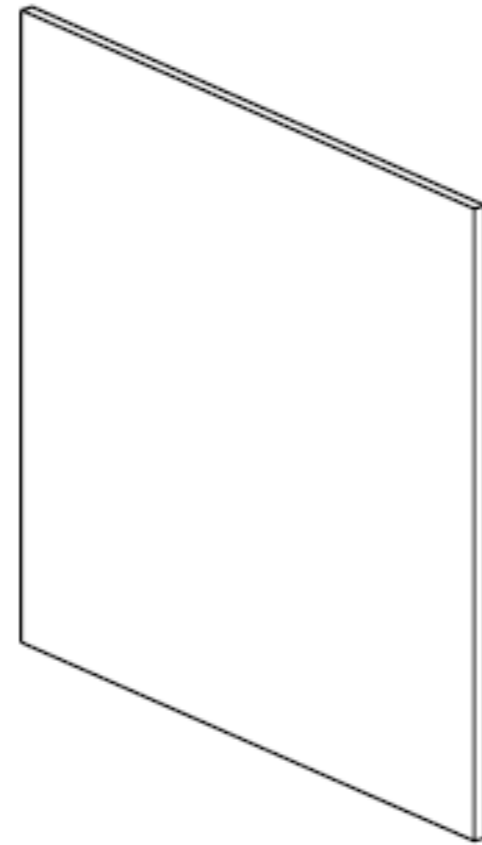

Wall sign backside with tape

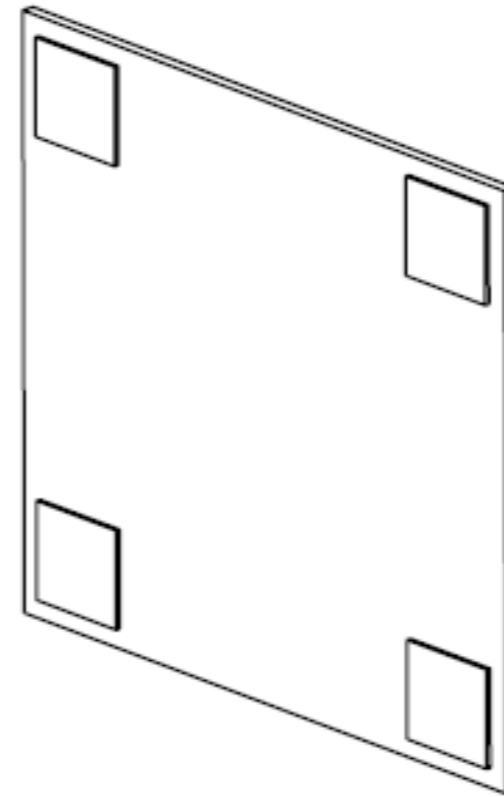

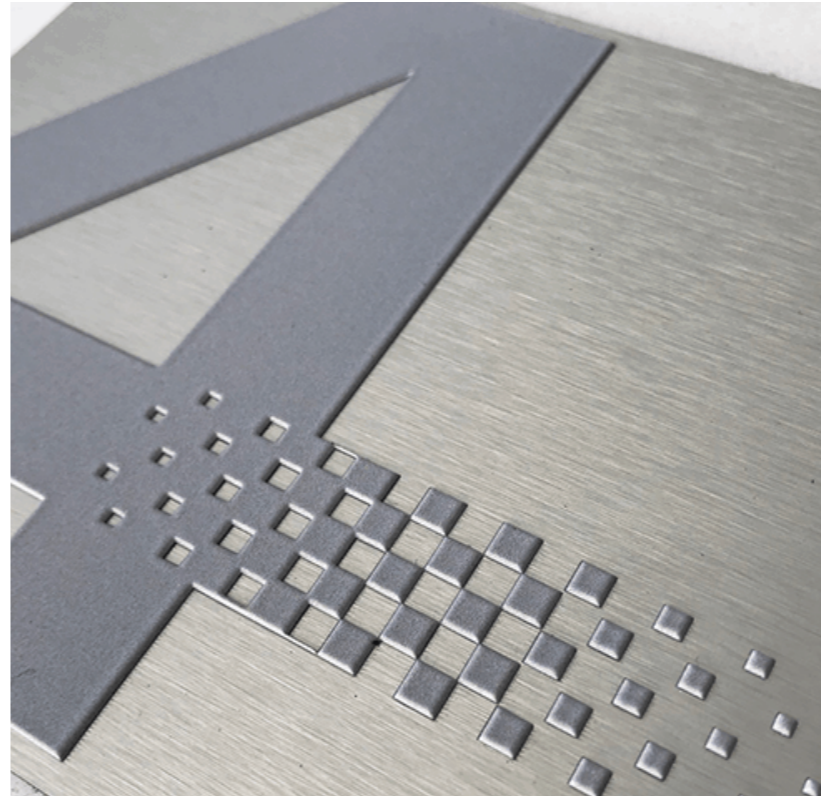
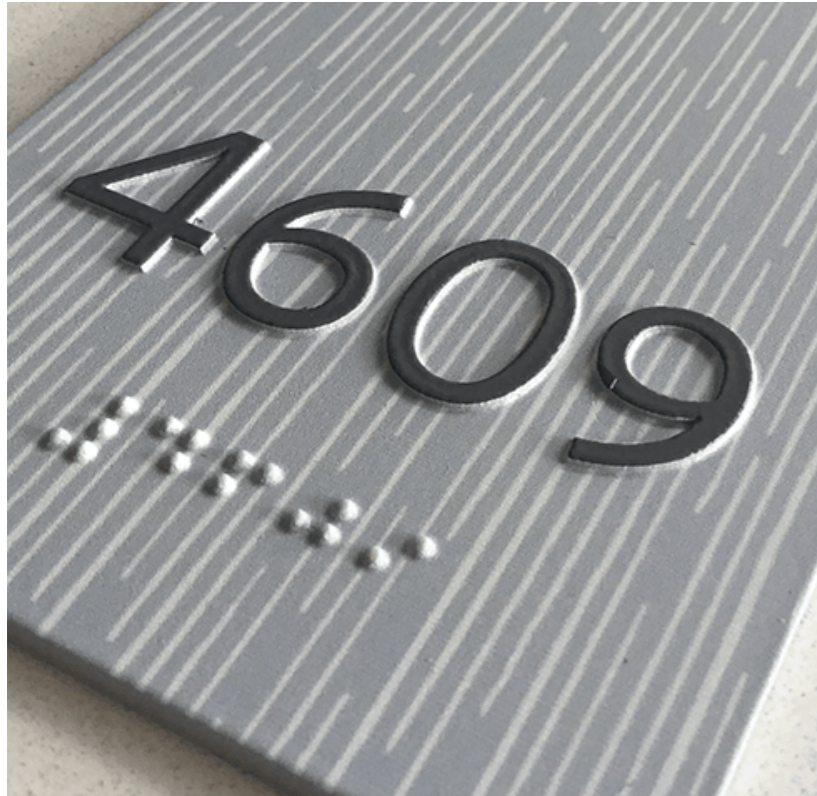

SIGNS FOR THE VISUALLY IMPAIRED.

Raised text and braille can be applied to nearly all standard Interior and Exterior sign products allowing users to create a coherent design which integrates braille and non braille signs without compromising the overall aesthetic of the signage scheme.



In order to support the needs of visually impaired visitors it is also advised that signs be produced with good contrast between letters and background, which should also contrast well with the background upon which it is mounted.

Tactile characters from Modulex are typically raised by 0.8 mm [0.0315], sufficient to support the requirements of visually impaired users.





SAFETY SIGNS.

Complying with the necessary requirements for public safety signage can be a quick process when selecting from the extensive range from Modulex. Whether you require evacuation signs, fire equipment signs or warning signs you can select your preferred fixing option from wall mounted, projecting and suspended.



SAFETY SIGNS.



For articles numbers please consult the next page

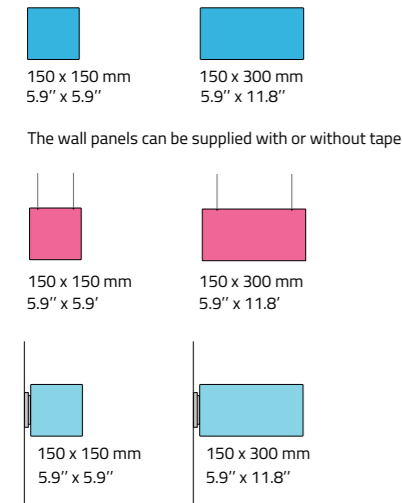

ISO 7010:2011 symbols

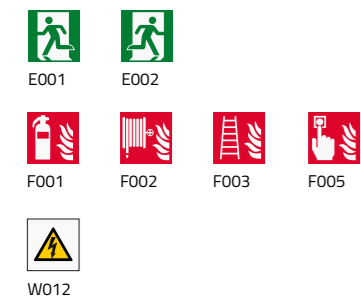

Evacuation signs

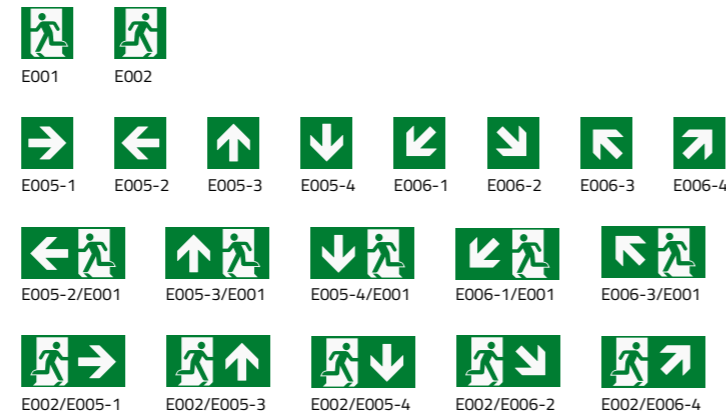

Fire equipment signs



Warning signs



Complementary signs



A: Without tape B: With tape D: Doublesided S: Singlesided										
150 x 150 mm 5.9" x 5.9"	A: 18301000 B: 18301600	A: 18301020 B: 18301620	A: 18301040 B: 18301640	A: 18301060 B: 18301660	A: 18301080 B: 18301680	A: 18301100 B: 18301700	A: 18301120 B: 18301720	A: 18301140 B: 18301740	A: 18301160 B: 18301760	A: 18301180 B: 18301780
150 x 150 mm 5.9" x 5.9"	D: 18311000	D: 18311020	D: 18311040	D: 18311060	S: 18311080	S: 18311100	D: 18311120	D: 18311140	D: 18311160	D: 18311180
150 x 150 mm 5.9" x 5.9"	D: 18321000	D: 18321020	D: 18321040	D: 18321060	S: 18321080	S: 18321100	D: 18321120	D: 18321140	D: 18321160	D: 18321180

A: Without tape B: With tape											
150 x 300 mm 5.9" x 11.8"	A: 18301380 B: 18301980	A: 18301400 B: 18302000	A: 18301420 B: 18302020	A: 18301440 B: 18302040	A: 18301460 B: 18302060	A: 18301480 B: 18302080	A: 18301500 B: 18302100	A: 18301520 B: 18302120	A: 18301540 B: 18302140	A: 18301560 B: 18302160	A: 18301580 B: 18302180
150 x 300 mm 5.9" x 11.8"	D: 18311380	S: 18311400	S: 18311420	D: 18311440	D: 18311460	D: 18311480	S: 18311500	S: 18311520	D: 18311540	D: 18311560	D: 18311580
150 x 300 mm 5.9" x 11.8"	D: 18321380	S: 18321400	S: 18321420	D: 18321440	D: 18321460	D: 18321480	S: 18321500	S: 18321520	D: 18321540	D: 18321560	D: 18321580

A: Without tape B: With tape											
150 x 150 mm 5.9" x 5.9"	A: 18301200 B: 18301800	A: 18301220 B: 18301820	A: 18301360 B: 18301960	A: 18301240 B: 18301840	A: 18301260 B: 18301860	A: 18301280 B: 18301880	A: 18301285 B: 18301885	A: 18301290 B: 18301890	A: 18301300 B: 18301900	A: 18301320 B: 18301920	A: 18301340 B: 18301940
150 x 150 mm 5.9" x 5.9"	D: 18311200	D: 18311220	D: 18311360	D: 18311240	D: 18311260	S: 18311280	D: 18311285	D: 18311290	S: 18311300	D: 18311320	D: 18311340
150 x 150 mm 5.9" x 5.9"	D: 18321200	D: 18321220	D: 18321360	D: 18321240	D: 18321260	S: 18321280	D: 18321285	D: 18321290	S: 18321300	D: 18321320	D: 18321340





OUR OFFICES & FACTORIES AROUND THE WORLD.

GLOBAL VISION • LOCAL REACH • ONE COMPANY



OFFICES



FACTORIES

› Africa

Algeria
Mozambique
Nigeria
South Africa

› Australia
& Asia

Australia
China
Hong Kong
India
Japan
Malaysia
Philippines
Taiwan
Thailand
Singapore
South Korea
Vietnam

› Caribbean

Aruba
Bahamas
Barbados
Bermuda
Cuba
Curacao
Dominican Republic
Grenada
Jamaica
Martinica
Puerto Rico
Trinidad and Tobago
Virgen Islands

› Europe

Austria
Belgium
Czech Republic
Finland
France
Germany
Greece
Hungary
Ireland
Italy
Netherlands
Norway
Poland
Portugal
Romania
Russia
Spain
Sweden
Switzerland
UK
Ukraine

› Middle
East

Bahrain
Cyprus
Iran
Iraq
Israel
Jordan
Kuwait
Lebanon
Qatar
Saudi Arabia
Turkey
UAE

› North
America

Canada
Mexico
USA

› South
America

Argentina
Bolivia
Brazil
Chile
Colombia
Ecuador
Paraguay
Peru
Uruguay
Venezuela





THANK YOU.

